

# 144-155 QUANTUM® 1.28

**MANSFIELD®**

Elongated Front, Pressure-Assist, Rear Outlet, Wall-Mount, Vitreous China Two-Piece Toilet

## FEATURES

- High performance pressure-assist, high efficiency toilet (HET)
- 1.28 gpf / 4.8 lpf high efficiency water consumption
- Uses 20% less water than conventional toilets
- Elongated rear outlet, wall-mount
- Model 45 chrome-plated metal trip lever
- 2' glazed trapway
- The Mansfield® limited lifetime warranty on china, Flushmate ten-year limited warranty on vessel
- Available in White







**MODEL 144-155**

Toilet seat not included



ELONGATED

## COMPONENTS

MODEL #	DESCRIPTION	CODES/STANDARDS
144-155	Elongated front, rear outlet, wall-mount pressure-assist, two-piece toilet. Includes tank trim and chrome-plated metal trip lever. Less toilet seat and supply.	   
144	Elongated front, rear outlet, wall-mount toilet bowl only. Less toilet seat and supply.	
155	Pressure-assist tank and cover only with left hand chrome-plated, metal trip lever. Less supply. Specify color.	
<b>TANK OPTIONS</b>		
155RH	Pressure-assist tank and cover only with right hand chrome-plated, metal trip lever. Less supply. Specify color.	
<b>TANK TRIM &amp; REPLACEMENT PARTS</b>		
45	Trip lever - chrome-plated, metal trip lever, left hand	
125-LID	Tank lid	
FLUSHMATE® 503	Pressure-assist flushing system. Separate warranty applies. Contact FLUSHMATE® at 1-800-533-3460.	





When properly installed, this product meets the requirements for the Americans with Disabilities Act of 1990 (ADA). Refer to local plumbing codes, as they may vary by location and application.

# 144-155 QUANTUM® 1.28



Elongated Front, Pressure-Assist, Rear Outlet, Wall-Mount, Vitreous China Two-Piece Toilet

## SPECIFICATIONS

MODEL #	DESCRIPTION	CODES/STANDARDS
144-155	Elongated front, rear outlet, wall-mount (1.28 gpf / 4.8 lpf) two-piece toilet	   

<b>MATERIAL</b>	Vitreous China
<b>WATER PRESSURE RANGE</b>	35 to 80 PSI
<b>FLUSH SYSTEM</b>	Flushmate™ flushing technology
<b>WATER USAGE</b>	1.28 gpf / 4.8 lpf
<b>WATER SURFACE AREA</b>	9-3/4" X 8"
<b>ROUGH-IN</b>	Rear outlet, wall mount
<b>MAP RATING</b>	Pending

<b>TRAP DIAMETER</b>	2"
<b>TRAP SEAL</b>	2-1/8"
<b>SHIPPING WEIGHT</b>	Model 144 - 61 lbs. (27.6 kg) Model 155 - 41 lbs. (18.5 kg)
<b>WARRANTY</b>	Vitreous China - Limited Lifetime Vessel - Limited Ten Year (Flushmate)

## TECHNICAL INFORMATION

**Note:** these dimensions are nominal and subject to change without notice.

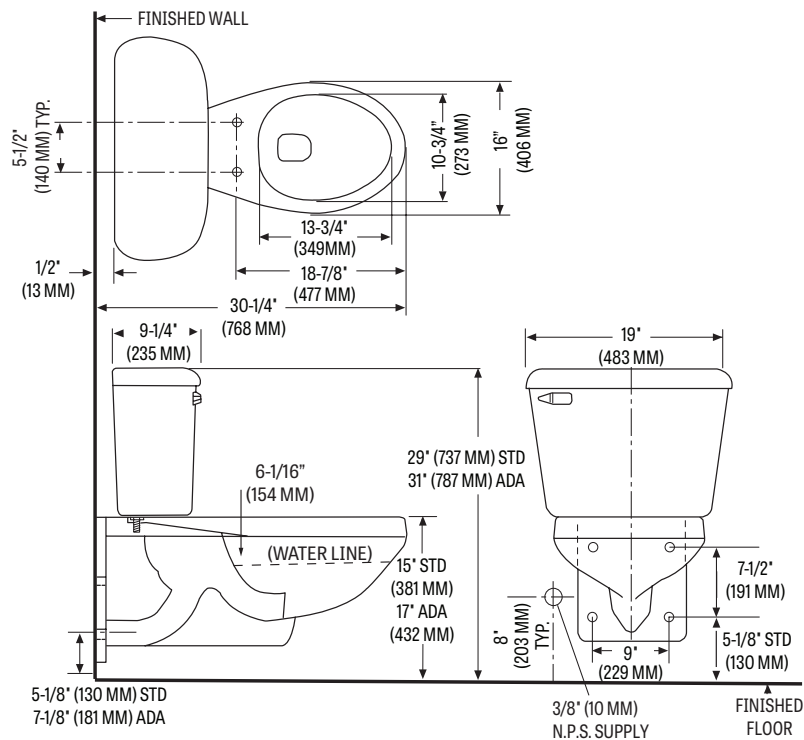

When properly installed, this product meets the requirements for the Americans with Disabilities Act of 1990 (ADA).

Refer to local plumbing codes, as they may vary by location and application.

Fixture performance and specifications meet or exceed ASME A112.19.2-2013/CSA B45.1-13 standards, and other state and local codes.